

ATHLETICS OMNIBUS - SHOT PUT

From the Boland Athletics website: www.bolandathletics.com

1. SHOT PUT

Shot Put is regarded as a strength event. The Shot Putter is required to push a steel ball as far as possible without throwing it. Depending on the age and gender of the athlete the weight of the implement will vary between 3kg to 7.26kg.

2. THE COMPETITION AREA

- **THE IMPLEMENT** - The shot must be of solid iron, brass or any metal not softer than brass, or a shell of such metal filled with lead or other material. The shot must be spherical in shape and the surface must be smooth. The weight of the implement will vary according to the age or gender of the athlete.
- **THE THROWING CIRCLE** - The inside diameter of the circle should be 2, 135 metres, the outside of the circle should be made of iron, steel or other suitable material and the top of the circle should be flush with the ground outside. The interior of the circle may be constructed of concrete, asphalt or some other firm but not slippery material. The surface should be level and should be 20mm lower than the outer edge of the rim of the circle. The circle is divided into two halves, which are indicated by a painted line drawn through the centre and extended outside the circle, not less than 0.75 metres on each side.
- **THE THROWING SECTOR** - This is formed by lines drawn from the centre of the circle and passing through the ends of the Stop Board, and thus making an angle of 34.92 degrees. The sector lines are 5cm in width.
- **THE STOP BOARD:** - The board should be made of wood or some other suitable material in the shape of an arc, so that the inner edge coincides with the inner edge of the circle, and also made so that it can be firmly fixed to the ground. It should be 1.22 metres in length and 114mm in width and 100mm high.

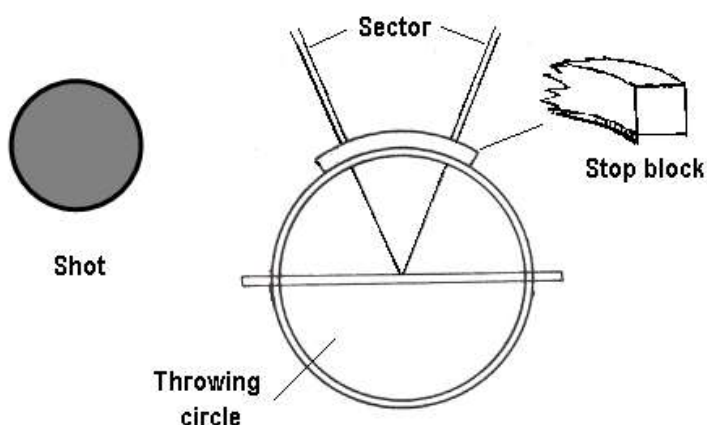

3. THE TECHNIQUE

The two most commonly used shot put techniques today are:

- a. The linear technique, commonly referred to as the o' Brien technique, and
- b. The rotational technique, similar to the discus throw technique.

The rotational technique is very technical, and if not executed well, the performance of the athlete will lack consistency. For this reason, it is advised for the novice to develop the linear technique and progress to the rotational technique at a later stage, if needed.

4. THE LINEAR TECHNIQUE

The right-handed technique will be explained in all examples used in this chapter.

The shot put technique comprises of the following phases:

- Preparation
- Glide
- Throw
- Recovery

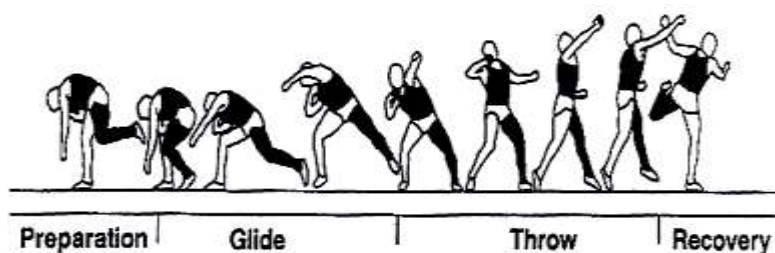

a. THE SHOT PUTTER SHOULD AVOID:

- i. Faulty balance in the initial position.
- ii. An incorrect glide through jumping from the right leg.
- iii. Lifting the trunk too high in the glide.
- iv. Not pulling the right leg far enough in beneath the body.
- v. Landing with the right foot facing the rear.
- vi. A movement of the left leg too much to the side.
- vii. A premature opening up of the trunk.
- viii. Landing with the trunk facing the side or to the front.

b. THE SHOT PUTTER SHOULD AIM TO:

- i. Keep the left leg fairly low.
- ii. Achieve a completely balanced action of the legs, with the left leg driving well back.
- iii. To keep the upper part of the body relaxed while the lower part is moving.
- iv. To achieve a fast and wide ranging movement of the right leg.
- v. Turn the right foot inwards during the glide.
- vi. Keep the left hip and shoulder facing the rear as long as possible.
- vii. Keep the left arm in a "closed position".
- viii. Resist strongly with the left leg.

5. PREPARATION

Place the Shot in the hand so that it remains clear of the palm.

This is done by resting the Shot on the base of the fingers and the fingers itself.

The middle three fingers should not be stretched apart.

The little finger and the thumb support the Shot on the sides.

The wrist bends back as far as possible.



Once the shot lies comfortable on the base of the fingers,

- ◆ place the Shot into the hollow base of the neck (in front of the ear),
- ◆ with the palm facing forwards,
- ◆ thumb pointing down
- ◆ and the elbow in a high position.



- Take up a modified 'T' position, facing away from the direction of the throw, eyes focused on a point 6 m behind the circle.
- The weight of the body is on the right leg.
- The shot must be directly above the right foot.
- The left leg must stay low and slightly bent to ensure good rhythm and movement during the start of the glide.



6. THE GLIDE

- Lower the trunk and bend the supporting leg with the shot remaining above the right foot.
- As the trunk is lowered, the heel of the supporting leg is raised.
- The athlete rolls back, and drives from the sole and heel of the supporting leg (1) when the hips are lower than the shoulders.
- Driving from the toe will lift the upper body prematurely. The heel must break contact at the back of the circle.
- The free leg is brought down and kicked backwards immediately and vigorously in the direction of the base of the stop-block.
- The glide must be done by the legs only. No assistance must come from the upper body or the free arm.
- The free arm is dragging behind.



- Point the thumb of the free arm down to keep it relaxed.
- The shoulders remain facing away from the direction of the throw in a closed position.

7. MID-GLIDE

- The right foot performs a low hop, clearing the ground to avoid the slowing down effect of a dragging foot.
- After the right foot left the ground, the foot, knee and hip rotate anti-clockwise.
- The right foot is quickly pulled back under the body, directly beneath the Shot, and land in the centre of the circle.
- The right foot land first after the hop, and shortly afterwards the left foot. Both feet land on their soles.
- The body weight is still on the right leg and in a chin-knee-toe position.
- The left foot land near the stop board and slightly to the left of the line of throw. If it land on the centre line, the hips will have problems coming through, and if it land too far from the centre line, the athlete will be off balance.
- The trunk starts to lean back, but the shoulders remain facing to the rear. This is done by forcing the free shoulder to stay low. The free arm remain long, relaxed (thumb pointing downwards), and to the rear.

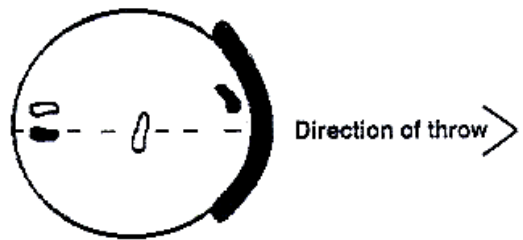
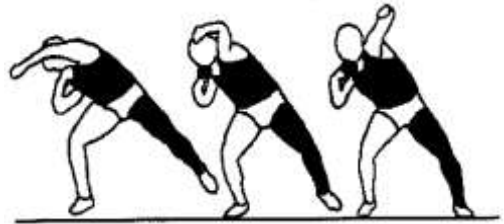

8. THE POWER POSITION

- More than 80% of the acceleration is produced during this phase.
- Both feet are now on the ground about 1m apart, with the weight still on the right leg, in a chin-knee-toe position.
- The right foot is in the 10 o'clock position if the direction of throw is in the 6 o'clock position.
- The left leg point in the direction of the throw (6 o'clock) with the left foot on the ground, slightly off centre.
- The hips are in an open position.
- The trunk is still slightly arched with the shoulders still square to the rear but slightly open.
- The eyes are looking back.

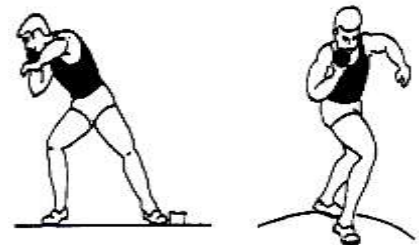

9. THE THROW

- The body weight is still on the right leg.
- The right hip is turned to the front, ahead of the shoulders, by extending the right leg (1), while the left side of the body is kept rigid.
- Extend the left knee only when the hips are square to the front, to gain maximum delivery height.
- Put the Shot at the same time, very late and very fast.
- Put the Shot with the elbow raised, directly behind the shot, in line with the throw (2).
- The throw is accompanied by the rapid extension of the right leg.
- The left arm is dragging behind to delay the rotation of the shoulders, and then remain firm (blocked) during the final thrust of the right side of the body. It must not be allowed to sweep too far backwards.
- The Shot must leave the hand only when the hand gave the last impulse to the Shot, and the left leg and foot is fully extended.
- The eyes follow the delivery.
- The legs/hips extension must lead the shoulder/ shot extension throughout the entire movement.
- The delivery angle is approximately 40°.

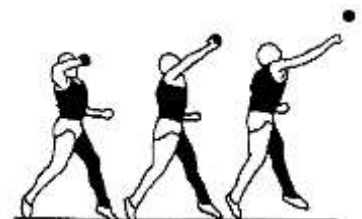

10. RECOVERY

- After putting the Shot, jump round placing the right leg forward.
- The trunk is dropped downwards to lower the centre of gravity.
- This is done by bending the right leg on landing.
- The left foot must stay close to the ground on its way back.

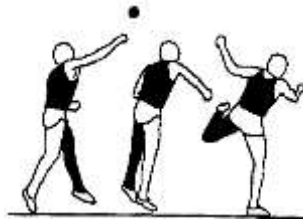

11. EXERCISES TO IMPROVE THE LINEAR TECHNIQUE

LEGS/ARMS CO-ORDINATION

To co-ordinate the legs and arms in the throwing movement, stand with the feet in line, the trunk leaning back slightly and with the Shot held in both hands in front of the chest. Step forward on the left foot and throw the shot with a simultaneous extension of arms and legs.

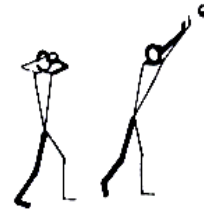

THE THROW

To learn the final movement, take up a position with the feet astride, with the body resting on a bent rear leg. The rear foot must be on the 'throwing line' and the forward foot slightly to the left of it. The trunk is turned to the rear and lowered slightly, with the left arm wrapped loosely across the chest. Rotate the right leg to the front, turn and straighten the trunk, extending both legs, and put the Shot.



GLIDE AND THROW

To learn the glide and link it up with the final action, stand with the left foot forward and facing the front, with the trunk upright and turned slightly to the side. Hop forward to land first on the right leg and then immediately on the left. Put the Shot immediately the left foot has landed.

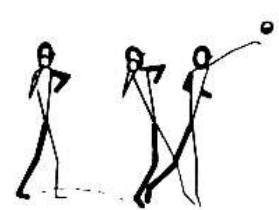

GLIDE WITHOUT FLIGHT

To learn the glide without using the flight phase, stand facing the rear with the left leg stretched back towards the direction of throwing. Pull the left leg in towards the right leg and immediately return it to its previous position, keeping the body turned towards the rear. The put can now be made from this position.

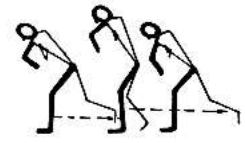

GLIDE TO POWER POSITION

To learn the technique of the glide, repeat only the glide several times, by pulling up the left leg and throw it out, while driving from the right leg.

Land on the right leg again in the power position. Check for correct feet alignment, position of the Shot, low trunk, relaxed left arm, etc.



SHORT GLIDE AND THROW

To combine the various phases of the put, do a complete throw, well controlled, with a very short and low glide.

The final action with the trunk must be executed with a good perpendicular position.

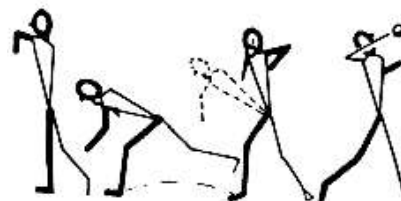

12. TRAINING

During the period of training, the conditioning philosophy will be as follows:

- Use an over distance approach.
- First quantity, then quality.
- Build a foundation of endurance and then develop speed gradually. This will prevent injury.
- For the first month of training you will do no speed work and you will not time anything.
- You will develop speed by doing a great deal of short, fast work and by improving your sprinting form.
- The test distance for endurance will be 300m, and test distance for speed will be 30-50 m. A jumper will only be successful when both tests are done well.
- As the season progresses, you will do less work but faster work.
- Workouts will generally be a hard day followed by an easy day, with a lightening up of work two days before competition or time trail.
- Your schedule is flexible. You may change the daily routine because of weather, body condition, or emotional outlook.
- You should completely recover from one workout to the next. If you are not completely recovered, do less work, or rest.
- You should never train when you are ill nor have an injury.
- If your training schedule is limited, you may telescope this schedule into two-week periods instead of month periods.
- Your workouts must be fun or rewarding, preferably both.

a. TRAINING SESSIONS

- All training sessions should always start off with warm-up session and stretching exercises.
- After all training sessions a cool down and stretching session should follow.
- Refer to the chapter on mobility for event specific warm –up and stretching exercises.

13. TYPES OF TRAINING

a. GENERAL CONDITIONING

The need for endurance training for the thrower, such as jogging sessions, is very small. However a change of environment is sometimes needed and circuit training in a gymnasium, a game of soccer or volleyball can come in handy.

b. TECHNIQUE

Technique exercises must be done on a regular basis. A high school athlete for example should throw at least 75 - 100 technique specific throws per week during the preparation phase and at least 40 full throws. At least 75 - 100 full throws should be executed per week during the high intensity phase.

c. MOBILITY

Strength training tends to reduce mobility especially in the ankle, hip and shoulder joints as well as the spine. This will drastically reduce the capacity to perform, and increase the injury risk. Intensive stretching exercises must be done with every technique session and must be event specific.

d. STRENGTH ENDURANCE

Strength endurance and muscle endurance are not taxed during competition but is necessary to develop to be able to cope with high quality output during long periods of training. It is also valuable when mental endurance is needed during concentration at an intense level over a long period of time.

Using medicine ball exercises or weight training at low intensity e.g. 75%, 10 - 20 repetitions and 3 - 5 sets can develop it.

e. MAXIMUM STRENGTH

Maximum strength is not valuable during the execution of the throw because of the slow muscle contraction, which develop because of maximum strength exercises. However, it provides the foundation upon which all other strength development is based e.g. specific strength, elastic strength and static strength.

Maximum strength can be developed with 80 - 100% weight lifting with 1 - 5 repetitions and 5 - 8 sets.

f. STATIC STRENGTH

Static strength is used during the blocking of the left side of the body, while the right side of the body delivers the implement. It is developed mainly during weight lifting sessions at 100% intensity with 1 - 3 repetitions and 1 - 3 sets.

g. SPECIFIC STRENGTH

Specific strength is developed when throwing with implements slightly heavier than competition implements, or with medicine balls.

h. ELASTIC STRENGTH

Elastic strength is developed during exercises such as jumping, bounding, and hopping and plays an important role in the delivery speed of the implement.

i. SPEED

General speed can be developed by means of:

- 30 - 50 m sprints,
- elastic strength exercises
- and explosive use of weight lifting.

j. SPECIFIC SPEED

For specific speed the athlete can use under-weight implements e.g. a shot with a hole drilled through. The lighter implement (not more than 15% lighter) will give the athlete the experience of throwing distances to which he aspires. To light implements will cause elbow injuries and destroy his timing for the event.

The exercises above are combined in a long term training program that would look more or less as follows:

THROWS LONG TERM PLAN	PHASE					
	Conditioning		Preparation		Competition	
Training Methods	1	2	1	2	1	2
General Conditioning	30%	25%	20%	15%	10%	5%
Technique + Mobility	20%	20%	25%	25%	25%	30%
Strength Endurance + Maximum Strength	30%	25%	20%	15%	10%	5%
Specific, Elastic And Static Strength	10%	15%	15%	25%	25%	20%
Speed + Competition	5%	10%	10%	10%	15%	20%
Active Rest	5%	5%	10%	10%	15%	20%

14. A TRAINING PROGRAM FOR THE THROWER

- If your training schedule is limited, you may telescope this one month cycles into two week cycles.
- Phase 1 of each sub-section of the program is used as a conditioning period for the new exercises.
- During phase 2 the intensity of the training is gradually increased.

- Two examples of a 14-day training program in all the throwing disciplines are given. One in the pre-season and one in the peak season.

CONDITIONING PHASE	MONTH													
CONDITIONING	M	T	W	T	F	S	S	M	T	W	T	F	S	S
General conditioning e.g. circuit training, volley ball		#		#					#		#			
Technique throws concentrating on specifics	#		#					#		#				
Full throw														
Mobility - event specific	#		#					#		#				
Endurance Strength		#		#					#		#			
Maximum Strength	#		#					#		#				
Static Strength														
Specific Strength														
Elastic Strength														
Speed														
Competition														
Rest					#	#	#					#	#	#

PREPARATION PHASE	MONTH													
CONDITIONING	M	T	W	T	F	S	S	M	T	W	T	F	S	S
General conditioning e.g. circuit training, volley ball				#							#			
Technique throws concentrating on specifics		#		#					#		#			
Full throw	#		#					#		#				
Mobility - event specific	#	#	#	#				#	#	#	#			
Endurance Strength		#		#					#		#			
Maximum Strength	#		#					#		#				
Static Strength														
Specific Strength			#							#				
Elastic Strength														
Speed	#							#						
Competition						#							#	
Rest					#	#	#					#	#	#

COMPETITION PHASE	MONTH													
CONDITIONING	M	T	W	T	F	S	S	M	T	W	T	F	S	S
General conditioning e.g. circuit training, volley ball														
Technique throws concentrating on specifics		#		#					#		#			
Full throw	#		#		#			#		#		#		
Mobility - event specific	#	#	#	#	#			#	#	#	#	#		
Endurance Strength														
Maximum Strength														
Static Strength	#		#					#		#				
Specific Strength		#		#					#		#			
Elastic Strength	#		#					#		#				
Speed	#		#					#		#				
Competition						#							#	
Rest				#	#	#	#				#	#	#	#

15. RULES

THE SHOT

The Shot must be of solid iron, brass or any metal not softer than brass, or a shell of such metal filled with lead or other material. The men's Shot weighs 7,26 kg and the woman's Shot 4 kg.

It must be spherical in shape and the surface must be smooth. The senior men's Shot has a maximum diameter of 130 mm and a minimum diameter of 110 mm and the woman's Shot a maximum of 110 mm and a minimum diameter of 95 mm.

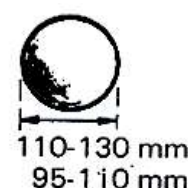

THE THROWING CIRCLE

The circle ring must be made of iron, steel or other suitable material and its inside diameter is 2,135 m. The top of the circle must be flush with the ground outside. The interior of the circle may be constructed of concrete, asphalt or some other firm but not slippery material. The surface must be level and must be 20 mm lower than the outer edge of the rim of the circle. The circle is divided into two halves, which are indicated by lines drawn from the top of the metal extending for at least 0,75 m on either side of the circle. The rear edge of these two lines, if continued across the circle, would meet at the centre of the circle.

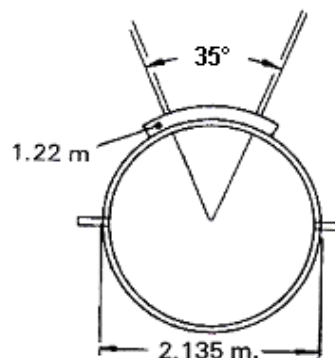

THE STOP-BOARD

The board should be made of wood or some other suitable material, in the shape of an arc, so that the inner edge coincides with the inner edge of the circle, and also made so that it may be firmly fixed to the ground.

The board must measure 1,21 m to 1,23 m long on the inside, 112 mm to 116 mm wide, and 98 mm to 102 mm high in relation to the level of the inside mark of the circle.

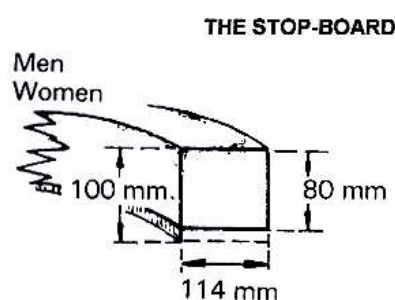

THE SECTOR

The Shot must fall so that the nearest mark made by the fall of the Shot is within the inner edges of lines 5 cm wide marking a sector of 34.92°, set out on the ground, so that the radii lines cross at the centre of the circle.

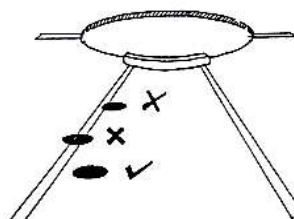

GENERAL RULES

1. The competitor must start from a stationary and balanced position inside the circle.
2. He must not leave the circle until the implement has touched the ground, and then his first contact with the ground outside the circle must be behind the line drawn outside.
3. The competitor may touch the inside edge of the stop-board, but not the top.
4. The Shot must be put from the shoulder with one hand only.
5. In the preliminary stance, it must be held close to the chin, and the hand must never drop below that position throughout the throw.
6. The put is measured from the nearest mark made by the fall of the Shot to the inside of the circumference of the circle, along a line from the mark made by the Shot to the centre of the circle.
7. Where there are more than eight competitors, each shall be allowed three trials, and the eight competitors with best performances shall be allowed three additional trials.
8. If there are eight competitors or fewer, each shall be allowed six trials.
9. At the competition area and before beginning the event, each competitor may have practice trials, in draw order and always under supervision of the Judges.
10. Once the competition has begun competitors are not permitted to use implements for practice purposes.
11. The throw shall be made from the circle. The competitor shall commence the throw from a stationary position.
12. It shall be a foul throw if the competitors, after he/she has stepped into the circle and begun to make a throw, touches with any part of his/her body the ground outside the circle or the top of the iron band.

13. A competitor may interrupt a trial once started and lay the implement down inside or outside the circle and leave the circle. When leaving the circle he/she shall step out as in point 8, before starting again as in point 4 and within his/her time limit.
14. For a valid trial, the shot shall fall completely within the inner edges of the landing sector.
15. The Chief Judge shall vary the distance against the national/provincial/competition record. In the case of a record, the measurement must be ratified by the Referee.
16. The competitor shall not leave the circle until the implement has touched the ground. When leaving the circle, the first contact with the iron band or the ground outside the circle shall be completely behind the white line drawn outside the circle.
17. Time allowed for a trial is 1 minute.
18. If two to three competitors continue the time should be increased to 1 minute.
19. If only one competitor is left the time should be increased to 2 minutes.
20. For consecutive trials by the same athlete when more than three athletes are still competing the time is 2 minutes.
21. All measurements must be made from the nearer edge of the first mark in the ground by the implement, to the inner edge of the circle rim along a line drawn from the mark to the centre of the circle.

BIBLIOGRAPHY

1. Basic Coaching Manual - I.A.A.F., 3 Hans Crescent, Knightsbridge, London SW1X, England.
2. But First - B.A.F. 225A Bristol Rd, Edgbaston, Birmingham B5 7UB.
3. IAAF Rule Book, IAAF 17,rue Princesse Florestine, B.P. 459, MC 98007, Monaco Cedex
4. Shot putting, Max Jones, - B.A.F. 225A Bristol Rd, Edgbaston, Birmingham B5 7UB.
5. Techniques of Athletics and Teaching Progressions - I.A.A.F., 3 Hans Crescent, Knightsbridge, London SW1X, England.